



2015

**5**  
YEAR  
WARRANTY



Verte model D7, Perfect Veneer, Oak California

Door collections to apartments



# NOVELTIES

---



MODEL E5, P. 18



MODEL F5, P. 18

left or right?  
no problem



**SMART**  
**SMART**



NON-REBATED UNIVERSAL  
DOOR FRAME **SMART**, P. 35



MDF DOOR FRAME  
FOR FORES DOOR LEAF P. 29



Detailed terms and conditions  
for VERTE doors available at:  
[www.vertedoors.eu/5year.pdf](http://www.vertedoors.eu/5year.pdf)

excluding Verte BASIC

## CONTENTS

VERTE BASIC, VERTE BASIC PLUS .....	8	NOVELTY
COLLECTION A .....	10	SUPER PRICE
COLLECTION B .....	12	SUPER PRICE
COLLECTION C .....	14	SUPER PRICE
COLLECTION D .....	16	SUPER PRICE
COLLECTION E, F .....	18	NEW MODELS
MODERN .....	20	NOW MODELS
OPTIMA .....	22	
WALL SYSTEM FOR SLIDING DOORS .....	24	
IN-WALL SYSTEM FOR SLIDING DOOR .....	26	
FORES BASIC – REINFORCED, ACOUSTIC .....	28	NOVELTY
VERTE STRONGER – ANTI-BURGLARY, ACOUSTIC .....	30	NOVELTY
DOOR LEAVES CONSTRUCTION .....	32	
UNIVERSAL NON-REBATED DOOR FRAME “SMART” .....	35	NOVELTY
FIXED DOOR FRAME .....	36	
ADJUSTABLE DOOR FRAME .....	37	
ACCESSORIES .....	38	
DOOR ASSEMBLY DIMENSIONS .....	40	
COLOR SAMPLES .....	43	

## SIMPLIFIED PRODUCT DATA SYSTEMISATION IN THE FORM OF ICON



Available **sizes** of single-leaf doors



Available **sizes** of double-leaf doors



**Sliding door leaf**



**Rebated doors**



**Non-rebated doors**



**Mechanical strength class class 1–4**  
Resistance to loads depending on the conditions of use



**Burglar-proofness**  
class 2, class 3, class C  
Resistance of the door to unauthorized opening



**Acoustic Insulation**  
Rw 27 dB D,25, Rw 32 dB D,30,  
Rw 37 dB D,35, Rw 42 dB D,40  
Specifies the number of decibels the door is able to isolate



**Smoke-proofness**  
Sa, Sm class  
Specifies smoke control class of the doors

# HOW TO MATCH DOORS TO THE STYLE OF THE INTERIOR?

MATCHING THE DOORS TO THE STYLE OF THE INTERIOR SEEMS LIKE QUITE A CHALLENGE.  
WHAT CRITERIA TO CONSIDER WHEN CHOOSING THE RIGHT DOOR FOR YOU?

Below you will find some solutions,  
which will give your living space  
a unified character  
and turn door selection into a joyful activity.

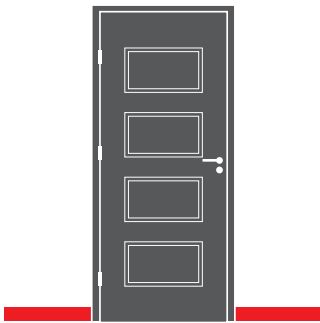

## BY SKIRTING BOARDS

Look at the color, height, finish, and style of the boards and choose the right doors for you.

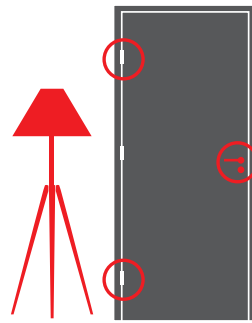

## BY DETAILS

Details make up the character of your apartment. Use them as a reference when choosing door accessories.

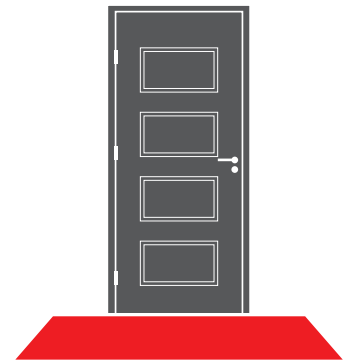

## BY FLOOR COLOR

Floor is an important part of your interior's decoration. Match the doors to the color of your floor or go the opposite way and decide for a contrasting color scheme.

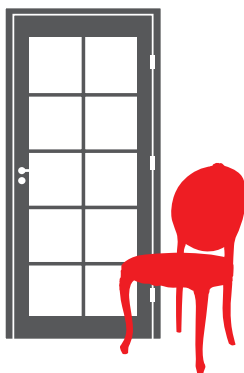

## BY STYLE

Each apartment can have its own style. Match the doors accordingly.

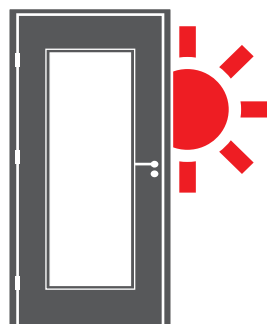

## BY LIGHTING

A room with no daylight access can be lighted up thanks to glass paned doors.

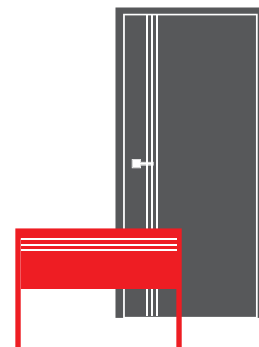

## BY FURNITURE COLOR

Furniture gives room its individual character and doors are a part of it. Match the door's color and structure to it.

# FRAME-AND-PANEL DOOR LEAVES

## ROBUST CONSTRUCTION

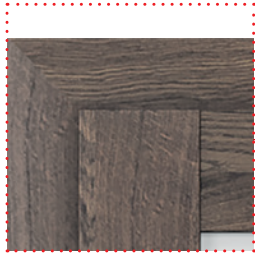

### INNOVATIVE SOLUTIONS

construction panels veneered along the perimeter; edges protected against moisture



### RELIABLE OPERATION

3 pintle hinges - standard offer



### ATTENTION TO DETAIL

no glazing seals



### SAFETY

matte tempered glass panel

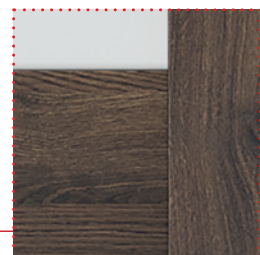

### SOLIDITY

frame-and-panel construction

# VARIOUS WALL THICKNESSES? IT'S NOT A PROBLEM!



BASIC RANGE  
95 – 110 mm

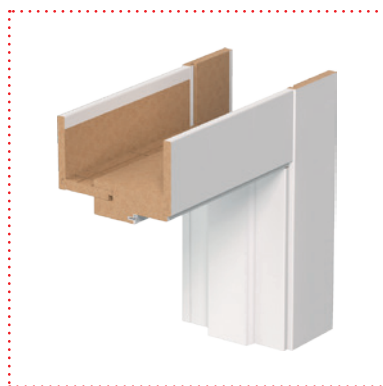

RANGE A  
95 – 210 mm

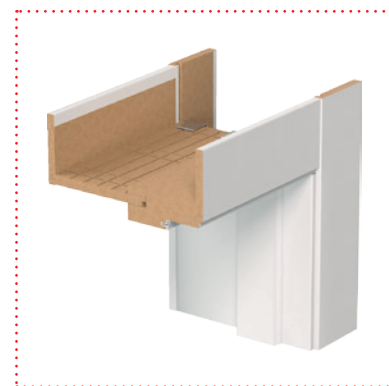

RANGE B  
95 – 310 mm

left or right?  
**no problem**



CLOSED DOOR



OPEN DOOR

## BASIC PACKAGE AND EXTENDED PANELS

**5**  
YEAR  
WARRANTY

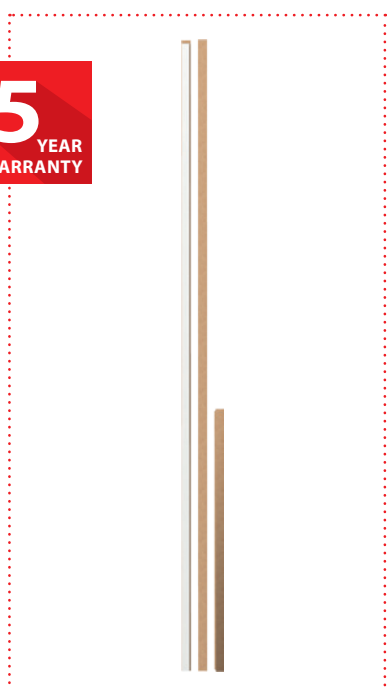

BASIC RANGE  
95 – 110 mm

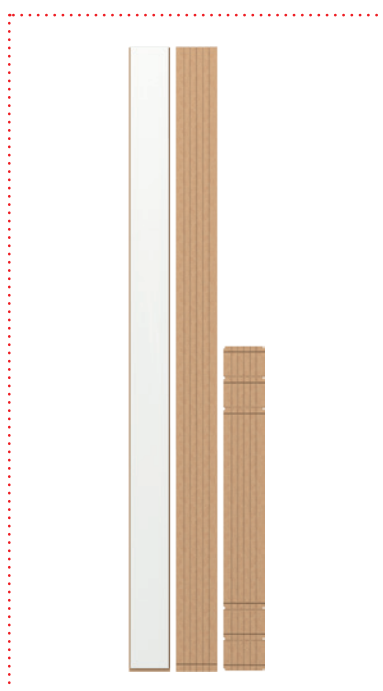

RANGE A  
95 – 210 mm

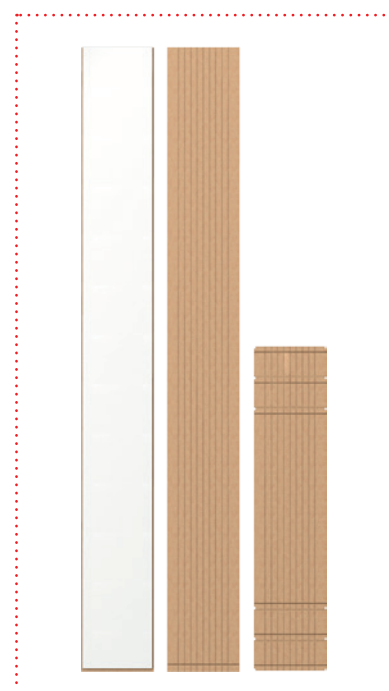

RANGE B  
95 – 310 mm

# NON-REBATED DOORS IN SMART SYSTEM

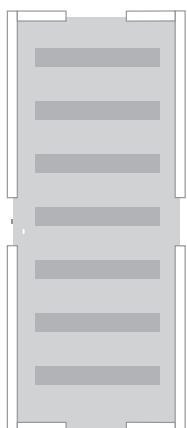

Universal door leaf SMART LEFT / RIGHT  
Available sizes "60" – "100"

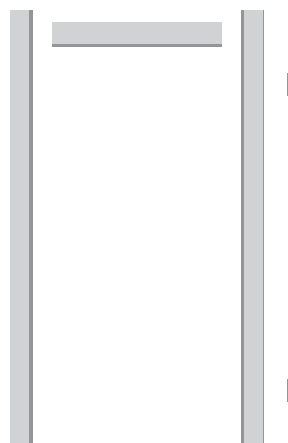

Universal door frame SMART LEFT / RIGHT  
In version for wall thickness "95" – "310"\*



I PURCHASE  
1SET

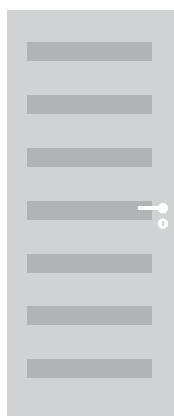

LEFT door leaf



LEFT door frame



RIGHT door leaf



RIGHT door frame



I ASSEMBLY IN  
2 OPTIONS



LEFT doors

left or right?  
no problem



RIGHT doors



I HAVE  
A CHOICE

# VERTE BASIC, VERTE BASIC PLUS



LARGE LIGHT AND NARROW LIGHT MODEL, OAK MONACO 3

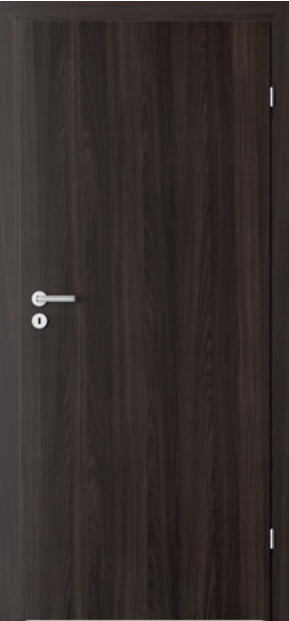

FULL



NARROW LIGHT



LARGE LIGHT



LIFT



LACQUERED BOARD (VERTE BASIC)



LACQUERED BOARD (VERTE BASIC PLUS)

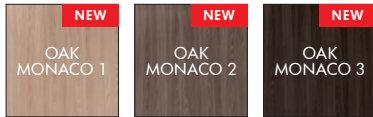

MODERN PROFILE OF FRAME  
VERTE BASIC PLUS



CLASSIC PROFILE OF FRAME  
VERTE BASIC



TRIO



BATHROOM



SASH

# COLLECTION A

**SUPER  
PRICE!**



MODEL A8, DUR VENEER, WALNUT 4

**5**  
YEAR  
WARRANTY



MODEL A0



MODEL A1



MODEL A2



MODEL A3



DECOR VENEER



DUR VENEER

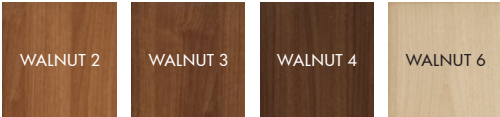

CORTEX VENEER

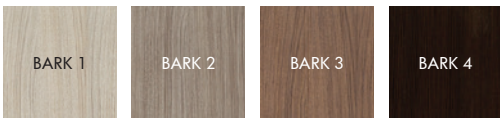

SYNCHRO 3D VENEER

TRENDS 2015



PERFECT 3D VENEER

TRENDS 2015



SUPER MATT VENEER



FLAT PANEL



MATTE TEMPERED GLASS PANEL



watch the video:  
[www.vertedrzwi.eu/technologie.mp4](http://www.vertedrzwi.eu/technologie.mp4)



MODEL A4



MODEL A5



MODEL A6



MODEL A8

# COLLECTION B

**SUPER  
PRICE!**



MODEL B3, DUR VENEER, WALNUT 3

**5**  
YEAR  
WARRANTY



MODEL B0



MODEL B1



MODEL B2



MODEL B3



DECOR VENEER



DUR VENEER

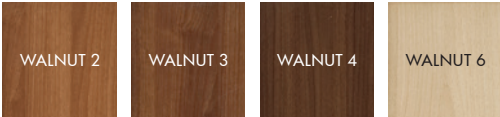

CORTEX VENEER

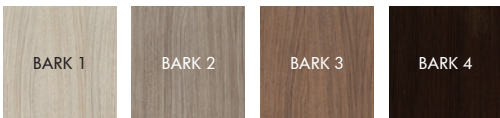

SYNCHRO 3D VENEER

TRENDS 2015



SYNCHRO 3D VENEER

PERFECT 3D VENEER

TRENDS 2015

SUPER MATT VENEER



DEDICATED GLASS PANEL



watch the video:  
[www.vertedrzwi.eu/technologie.mp4](http://www.vertedrzwi.eu/technologie.mp4)



MODEL B4



MODEL B5



MODEL B6



MODEL B7

# COLLECTION C

**SUPER  
PRICE!**



MODEL C5, PERFECT 3D VENEER, OAK HAVANA

**5**  
YEAR  
WARRANTY



MODEL C0



MODEL C1



MODEL C2



MODEL C3



DECOR VENEER



DUR VENEER



CORTEX VENEER

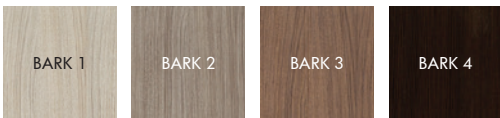

SYNCHRO 3D VENEER

TRENDS 2015



PERFECT 3D VENEER

TRENDS 2015



SUPER MATT VENEER



PANEL CONSTRUCTION



MATTE TEMPERED GLASS PANEL



watch the video:  
[www.vertedrzwi.eu/technologie.mp4](http://www.vertedrzwi.eu/technologie.mp4)



MODEL C4



MODEL C5

# COLLECTION D

**SUPER  
PRICE!**



MODEL D7, DUR VENEER, WALNUT 4

**5**  
YEAR  
WARRANTY



MODEL D0



MODEL D1



MODEL D2



MODEL D3





DECOR VENEER



DUR VENEER

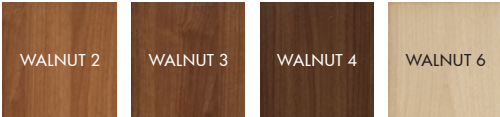

CORTEX VENEER

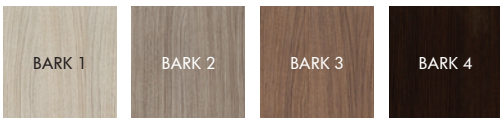

SYNCHRO 3D VENEER

TRENDS 2015



PERFECT 3D VENEER

TRENDS 2015



SUPER MATT VENEER



PERFECT 3D VENEER – HAPTIC EFFECT\*\*



MATTE TEMPERED GLASS PANEL



watch the video:  
[www.vertedrzwi.eu/technologie.mp4](http://www.vertedrzwi.eu/technologie.mp4)



MODEL D4



MODEL D5



MODEL D6



MODEL D7

\*\* Veneer with the woodlike structure effect

# COLLECTION E, F

**NEW  
POSSIBILITIES**



MODEL F5, PERFECT 3D VENEER, OAK MALIBU

**5**  
YEAR  
WARRANTY



MODEL E0



MODEL E1



MODEL E2



MODEL E3



DECOR VENEER



DUR VENEER

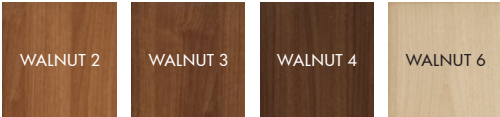

CORTEX VENEER

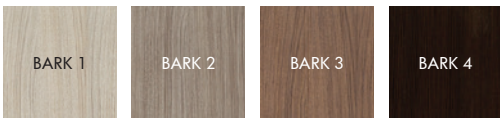

SYNCHRO 3D VENEER

TRENDS 2015



PERFECT 3D VENEER

TRENDS 2015



SUPER MATT VENEER



MINIMALIST FORM



MODEL E5 GLAZING



watch the video:  
[www.vertedrzwi.eu/technologie.mp4](http://www.vertedrzwi.eu/technologie.mp4)



MODEL E4



MODEL E5



MODEL F5

# MODERN



MODEL 3.1, 3.4, DECOR VENEER, WALNUT VERONA 2

**5**  
YEAR  
WARRANTY



MODEL 1.2



MODEL 2.7



MODEL 3.4



MODEL 4.4



DECOR VENEER



SYNCHRO 3D VENEER

TRENDS 2015



ALUMINIUM MARQUETRY, MODEL 1.2



MATTE TEMPERED GLASS PANEL



MODEL 5.5



MODEL 6.0



MODEL 6.1



MODEL 6.2

# OPTIMA



MODEL B0, B1, DECOR VENEER, WHITE

**5**  
YEAR  
WARRANTY



MODEL A0



MODEL A1



MODEL A2



MODEL A3



DECOR VENEER



SYNCHRO 3D VENEER

TRENDS 2015



UNIQUE DESIGN



MATTE TEMPERED GLASS PANEL



MODEL B0



MODEL B1



MODEL B2

# WALL SYSTEM FOR SLIDING DOORS



MODEL B5, DECOR VENEER, WHITE WALNUT, WALNUT

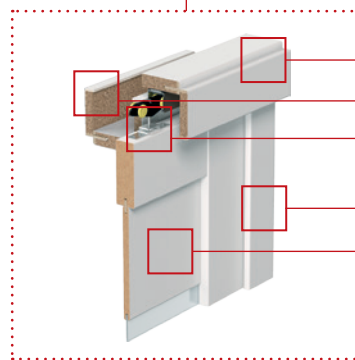

MASKING BEAM

ADJUSTABLE DOOR FRAME IN "TUNNEL VERSION"

RAIL WITH TROLLEYS

FENDER BEAM

DOOR LEAF IN SLIDING VERSION



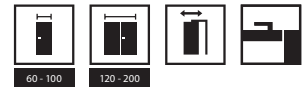

## DECOR VENEER



## DUR VENEER



## CORTEX VENEER

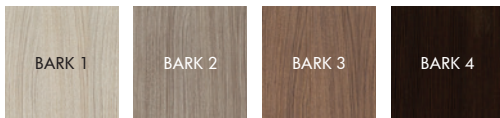

## SYNCHRO 3D VENEER

TRENDS 2015



## PERFECT 3D VENEER

TRENDS 2015



## SUPER MATT VENEER

## VERTE WALL SYSTEM FOR SLIDING DOORS

A complete wall<sup>1</sup> mounted sliding door consists of the following:

- wall mounted system
- sliding door leaf<sup>2</sup>
- "tunnel" type door frame for the sliding system<sup>2</sup>

## CONSTRUCTION

Wall system for sliding doors consist of:

- masking beam and fender beam made of chipboard and MDF
- rail with trolleys, complete with a shield
- sliding system is manufactured and delivered in the form of a set of elements to be assembled on the site

## FINISHING

A masking beam and fender beam are veneered with VERTE veneers (Decor, Dur, Cortex, Synchro 3D, Perfect 3D, Super Matt).

## ACCESSORIES

- rail with trolleys
- self - adhesive brush seal
- leaf guide (to be fitted to the floor)
- hock lock strike (option)

## DIMENSIONS

- single doors: "60", "70", "80", "90", "100"

## NOTES

- The sliding door system should be fitted in the rooms with finished wall (wallpaper, painting, glazing) and floors (parquet, lining, terracotta etc.).
- <sup>1</sup> This is a universal two-sided system. In order to change the direction of door opening it is enough to install the fender beam on the left or right side of the "tunnel" type door frame, as needed.
- <sup>2</sup> Not included in the price.

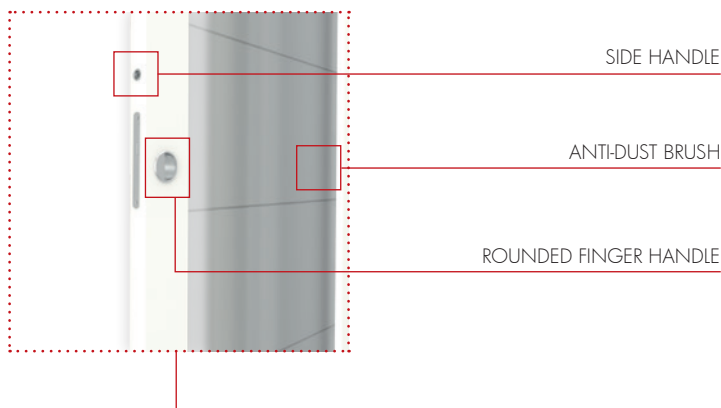

# IN-WALL SYSTEM FOR SLIDING DOORS



MODEL D7, DECOR VENEER, WHITE

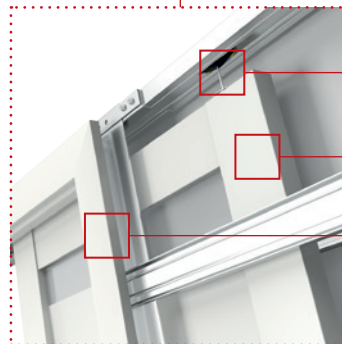
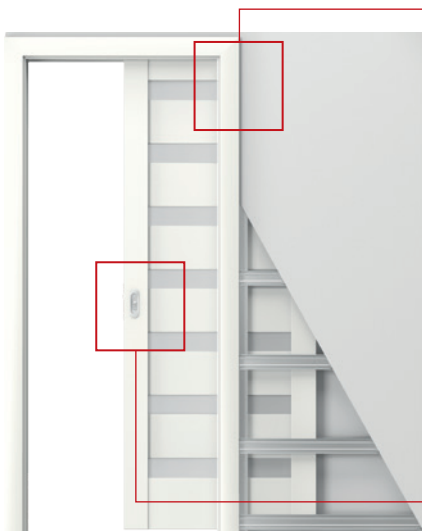

CASING WITH RAIL AND TROLLEYS

SLIDING DOOR LEAF\*

DOOR FRAME FOR IN-WALL SLIDING SYSTEM



## DECOR VENEER



## DUR VENEER

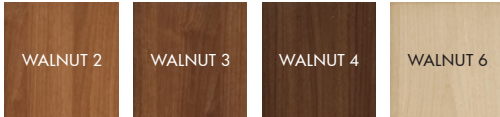

## CORTEX VENEER

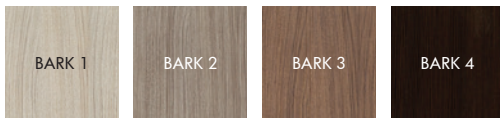

## SYNCHRO 3D VENEER

TRENDS 2015



## PERFECT 3D VENEER

TRENDS 2015



## SUPER MATT VENEER

## VERTE IN-WALL SLIDING DOOR SYSTEM

A complete in-wall sliding door system consists of:

- VERTE in-wall mounted system<sup>1</sup>
- sliding door leaf<sup>2</sup>

## CONSTRUCTION

VERTE in-wall sliding door system consists of the following:

- in-wall mounted casing complete with rail and trolleys
- door frame made of chipboard and MDF

## FINISHING

- door frame is veneered with VERTE veneers (Decor, Dur, Cortex, Synchro 3D, Perfect 3D, Super Matt)
- casing and rail are made of galvanized sheet steel, rail is made of aluminium
- trolleys and steel mounting screw

## ACCESSORIES

- construction casing
- rail with trolleys
- self-adhesive brush seal
- leaf guide (to be fitted to the floor)
- door frame
- fasteners
- hook lock strike (option).

## DIMENSIONS

- single door: "60", "70", "80", "90", "100"
- double doors: "60+60", "70+70", "80+80", "90+90", "100+100"

## NOTES

- The sliding door system should be fitted in the rooms with finished walls (wallpaper, painting, glazing) and floors (parquet, lining, terracotta etc.).
- Sliding system is manufactured and delivered to the customer as a set of elements to be assembled on the site.
- **Casing size "70", "80", "90", available directly from the manufacturer.**
- <sup>1</sup> The system is ready for assembling in an opening of a 125 mm thick gypsum board wall.
- <sup>2</sup> Not included in the price.

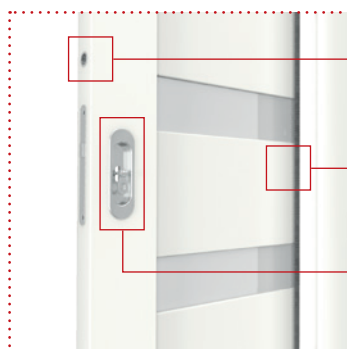

SIDE HANDLE

ANTIDUST BRUSH

HOOK LOCK